

SKY PRODIGY™ COMPUTERIZED TELESCOPE



SkyProdigy 102

ITEM #22090

INSTRUCTION MANUAL

TABLE OF CONTENTS

INTRODUCTION	4
Warning	4
SkyProdigy Models	5
ASSEMBLY	7
Assembling SkyProdigy	7
Attaching the Hand Control Holder	7
Attaching the Fork Arm to the Tripod	7
Attaching the Telescope to the Fork Arm	8
The Star Diagonal	8
The Eyepiece	8
Focusing	9
Attaching the Hand Control	9
Powering SkyProdigy	9
The StarPointer Finderscope	10
StarPointer Installation	10
StarPointer Operation	10
HAND CONTROL	11
The Hand Control	11
Aligning SkyProdigy	11
StarSense Alignment	12
Manual StarSense Alignment	13
Solar Sytem Alignment	13
Refine Alignment	14
Object Catalog	14
Selecting an Object	14
Slewing to an Object	14
SkyTour Button	14
Identify Button	15
Direction Buttons	15
Motor Speed Button	15
Help Button	15
Menu Button	15
Basic Level Menu Items	16
Time and Location	16
View/ GOTO Location	16
Utility Features	16
Backlight	16
LCD Contrast	16
Get Version Info	16
Restore Defaults	16
Menu Level	16

Advanced Level Menu Items	16
Database Setup	16
Telescope Setup	17
Tracking	17
Slew Limits	17
Direction Buttons	17
Cordwrap	17
Backlash Compensation	17
StarSense Camera	17
SKYPRRODIGY MENU TREE	19
TELESCOPE BASICS	20
Focusing	20
Image Orientation	20
Calculating Magnification	20
Determining Field of View	20
General Observing Hints	20
CELESTIAL OBSERVING	21
Observing the Moon	21
Lunar Observing Hints	21
Observing the Planets	21
Planetary Observing Hints	21
Observing the Sun	21
Solar Observing Hints	21
Observing Deep Sky Objects	21
Seeing Conditions	22
Transparency	22
Sky Illumination	22
Seeing	22
TELESCOPE MAINTENANCE	23
Care and Cleaning of the Optics	23
Collimation	23
APPENDIX A - TECHNICAL SPECIFICATIONS	25
APPENDIX B – GLOSSARY OF TERMS	26
APPENDIX C – TIME ZONE MAP	29

INTRODUCTION

Congratulations on your purchase of Celestron's SkyProdigy telescope! SkyProdigy ushers in a whole new generation of computer automated technology. It combines electronic motors, a digital camera and internal *StarSense™ Technology to create an automatic, instant alignment telescope that requires no input from the user. Simply turn it on, push a button and enjoy the view! It's that easy. If you are new to astronomy, you may wish to start off by using SkyProdigy's built-in Tour feature, which commands SkyProdigy to find the most interesting objects in the sky and automatically slews to each one. Or if you are more experienced, you will appreciate the comprehensive database of over 4,000 objects, including customized lists of all the best deep-sky objects, planets and bright double stars. No matter what level you are starting out, SkyProdigy will unfold for you and your friends all the wonders of the Universe.

Some of the many standard features of SkyProdigy include:

- Maximum 3.5°/second slew speed
- Fully enclosed motors and optical encoders for position location
- StarSense™ sky alignment digital camera for sky mapping
- Computerized hand controller with 4,000 object database
- Storage for programmable user defined objects; and
- Many other high performance features!

SkyProdigy's deluxe features combined with Celestron's legendary optical standards give amateur astronomers one of the most sophisticated and easy to use telescopes available on the market today.

SkyProdigy's Computerized Hand Control has built-in instructions to guide you through all the features needed to have the telescope up and running in minutes. Use this manual in conjunction with on-screen instructions provided by the hand control. The manual gives detailed information regarding each step as well as needed reference material and helpful hints guaranteed to make your observing experience as simple and pleasurable as possible.

Your SkyProdigy telescope is designed to give you years of fun and rewarding observations. However, there are a few things to consider before using your telescope that will ensure your safety and protect your equipment. See warning below.



*Celestron's SkyProdigy telescope uses an integrated imaging camera and patented StarSense Technology to automatically align itself with the night sky and determine where the telescope is currently pointing. The camera automatically captures an image of the sky, which is processed internally to positively identify the stars in the image. Once a positive match is found, SkyProdigy determines the coordinates of the center of the captured image. The process is automatically repeated two more times so that the system has three known alignment points that can be used to make an accurate model of the night sky. From this information the user can select any celestial object in the hand controller's database, and SkyProdigy will automatically move itself to the correct position.

***The SkyProdigy's internal camera does not have an external output allowing users to view or save the captured images. The captured images are used internally solely for the purpose of self-aligning the SkyProdigy telescope.**

WARNING



- **Never look directly at the Sun with the naked eye or with a telescope (unless you have the proper solar filter). Permanent and irreversible eye damage may result.**
- Never use your telescope to project an image of the Sun onto any surface. Internal heat build-up can damage the telescope and any accessories attached to it
- Never use an eyepiece solar filter or a Herschel Wedge. Internal heat build-up inside the telescope can cause these devices to crack or break, allowing unfiltered sunlight to pass through to the eye
- Never leave the telescope unsupervised, either when children are present or adults who may not be familiar with the correct operating procedures of your telescope

SkyProdigy 102 Telescope



- | | |
|----------------------------|----------------------|
| 1. Optical Tube | 7. Tripod |
| 2. StarPointer Finderscope | 8. Accessory Tray |
| 3. Eyepiece | 9. Hand Control |
| 4. Diagonal | 10. Fork Arm |
| 5. Focus Knob | 11. StarSense Camera |
| 6. Tube Clamp Knob | 12. Objective Lens |

SkyProdigy 6 Telescope



1. Optical Tube	6. Tripod
2. StarPointer Finderscope	7. Accessory Tray
3. Eyepiece (Not Shown)	8. Hand Control
4. Diagonal (Not Shown)	9. Fork Arm
5. Tube Clamp Knob	10. StarSense Camera

ASSEMBLY

SkyProdigy comes partially assembled and can be operational in a matter of minutes. SkyProdigy is conveniently packaged in one reusable shipping carton that contains the following accessories:

- 25 mm and 9 mm Eyepieces – 1¼"
- 1¼" Star Diagonal
- StarPointer Finderscope and Mounting Bracket
- Deluxe Accessory Tray
- TheSkyX First Light Astronomy Software
- Computerized Hand Control

Assembling SkyProdigy

Your SkyProdigy comes in three major sections: the optical tube, fork arm and tripod. These sections can be attached in seconds using the quick release coupling screw located under the tripod mounting platform and the dovetail mounting clamp located on the inside of the fork arm. To begin, remove all of the accessories from their individual boxes. Remember to save all of the containers so that they can be used to transport the telescope. Before attaching the visual accessories, the telescope tube and fork arm should be mounted to the tripod. First, install the accessory tray onto the tripod legs:

1. Remove the tripod from the box and spread the legs apart until the center leg brace is fully extended.
2. Locate the accessory tray, and place it on top of the tripod center support brace in between the tripod legs (see figure 2-1).
3. Rotate the accessory tray so that the central hole in the tray slides over the flange post in the center of the support bracket.
4. Finally, rotate the tray so that the locking tabs slide under the locking clips on the support bracket. You will hear the tray snap into place.

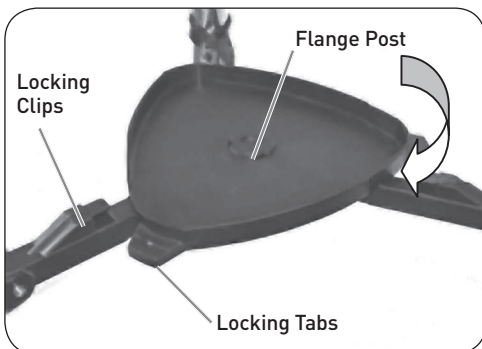

FIGURE 2-1

It is a good idea to level the tripod and adjust the height of the tripod legs before attaching the fork arm and tube. Minor adjustments can be made later. To adjust the height of the tripod legs:

1. Loosen the tripod leg locking bolt located on the side of each leg.

2. Slide the inner portion of each leg down 6" to 8" inches.
3. Adjust the tripod height until the bubble level on the tripod leg is centered (See figure 2-2).
4. Tighten the tripod locking bolts to hold each leg in place.



FIGURE 2-2
Leveling Tripod

Attaching the Hand Control Holder

SkyProdigy comes with a snap-on hand control holder that conveniently attaches to any of the tripod legs. To attach the hand control holder simply position the holder with the square plastic tab facing up and push against the tripod leg until it snaps into place (See figure 2-3).



FIGURE 2-3

Attaching the Fork Arm to the Tripod

With the tripod properly assembled, the telescope tube and fork arm can easily be attached using the quick release coupling screw located underneath the tripod mounting platform:

1. Place the fork arm base inside the tripod mounting platform.
2. Thread the coupling screw into the hole at the bottom of the fork arm base and hand tighten (See figure 2-4).

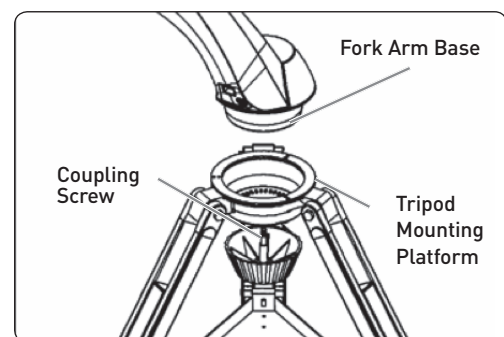

FIGURE 2-4

Attaching the Telescope to the Fork Arm

Your telescope optical tube has a built on dovetail mounting bar used to attach the tube to the fork arm. To attach the telescope tube (See figure 2-5).

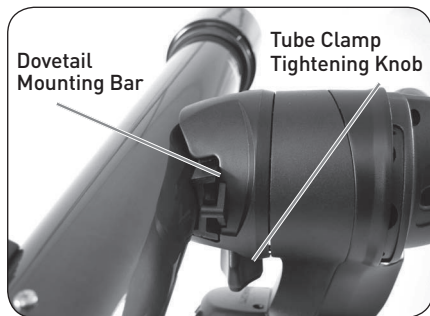

FIGURE 2-5

1. Loosen the tube clamp tightening knob.
2. Slide the dovetail mounting bar of the telescope tube into the fork arm clamp until it touches the positioning stop. Make sure that the logo on the side of the tube is right side up when the tube is aligned with the fork arm.
3. Tighten the tube clamp knob by hand to secure the tube to the fork arm.

Your SkyProdigy is fully assembled and is ready to attach the accessories.

The Star Diagonal

The star diagonal diverts light at a right angle from the light path of the telescope. For astronomical observing, this allows you to observe in positions that are more comfortable than if you were to look straight through. To attach the star diagonal:

1. Turn the thumbscrew on the eyepiece adapter at the end of the focuser barrel until it no longer extends into (i.e., obstructs) the inner diameter of the focus barrel/ visual back. Remove the protective dust cap from the focus barrel/ visual back.
2. Slide the chrome portion of the star diagonal into the eyepiece adapter.
3. Tighten the thumbscrew on the focus barrel/ visual back to hold the star diagonal in place.

If you wish to change the orientation of the star diagonal, loosen the thumbscrew on the eyepiece adapter until the star diagonal rotates freely. Rotate the diagonal to the desired position and tighten the thumbscrew.

The Eyepiece

The eyepiece, is the optical element that magnifies the image focused by the telescope. To install the eyepiece:

1. Loosen the thumbscrew on the star diagonal so it does not obstruct the inner diameter of the eyepiece end of the diagonal.
2. Remove the protective dust cap from the star diagonal's barrel.
3. Slide the chrome portion of the low power 25 mm eyepiece into the star diagonal.
4. Tighten the thumbscrew to hold the eyepiece in place.

To remove the eyepiece, loosen the thumbscrew on the star diagonal and slide the eyepiece out.

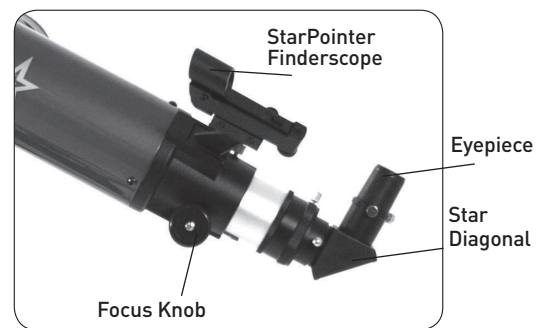

FIGURE 2-6

VISUAL ACCESSORIES FOR SKYPRODIGY 102

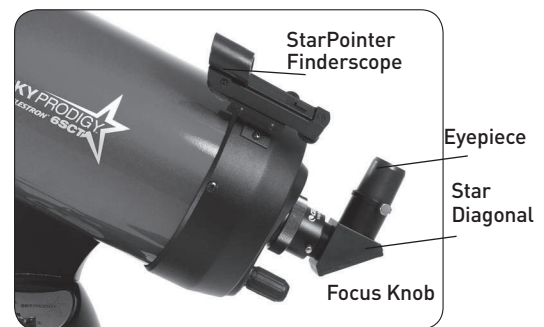

FIGURE 2-7

VISUAL ACCESSORIES FOR SKYPRODIGY 6

Eyepieces are commonly referred to by focal length and barrel diameter. The focal length of each eyepiece is printed on the eyepiece barrel. The longer the focal length (i.e., the larger the number) the lower the eyepiece power or magnification; and the shorter the focal length (i.e., the smaller the number) the higher the magnification. Generally, you will use low-to-moderate power when viewing. For more information on how to determine power, see the section on “Calculating Magnification”.

Barrel diameter is the diameter of the barrel that slides into the star diagonal or focuser. SkyProdigy uses eyepieces with a standard 1-1/4” barrel diameter.

Focusing

For astronomical viewing, out of focus star images are very diffuse, making them difficult to see. If you turn the focus knob too quickly, you can go right through focus without seeing the image. To avoid this problem, your first astronomical target should be a bright object (like the Moon or a planet) so that the image is visible even when out of focus. To get the focus close, start by focusing on a distant daytime object at least a quarter of a mile away.

For SkyProdigy 102:

To focus your telescope, simply turn either of the focus knobs at the eyepiece end of the optical tube (see figures 2-6 and 2-7). Turn the focus knob until the image is sharp. Once sharp, turn the knob towards you to focus on an object that is closer than the one you are currently observing. Turn the knob away from you to focus on a more distant object than the one you are currently observing. The mm and 102 mm has a silver focusing tension screw used to lock the focuser in place.

For SkyProdigy 6:

The focusing knob, which moves the primary mirror, is located on the rear of the telescope next to the star diagonal and eyepiece. Turn the focusing knob until the image is sharp. Once an image is in focus, turn the knob clockwise to focus on a closer object and counterclockwise for a more distant object. If the knob will not turn, it has reached the end of its travel on the focusing mechanism. Turn the knob in the opposite direction until the image is sharp.

Attaching the Computerized Hand Control

SkyProdigy’s hand control has a phone jack type connector at the end of its cord. Plug the phone jack connector into the outlet at the base of the telescope’s fork arm. Push the connector into the outlet until it clicks into place and place the hand control into its holder as described previously in the Assembly section of the manual.

Powering the SkyProdigy

SkyProdigy can be powered by 8 user supplied D-size alkaline batteries or an optional 12v AC adapter.

To power SkyProdigy:

1. Insert 8 D-batteries into battery pack.
2. Plug the battery packs barrel connector into the 12v outlet on the base of the telescope.
3. Flip the power switch to the “On” position. The light on the power button and hand control display will come on.

In case of a loss of power, the optical tube can be moved by hand in altitude (up and down) only. However, when powered on, the telescope should always be controlled using the hand control. SkyProdigy will lose its star alignment if moved by hand when powered on.

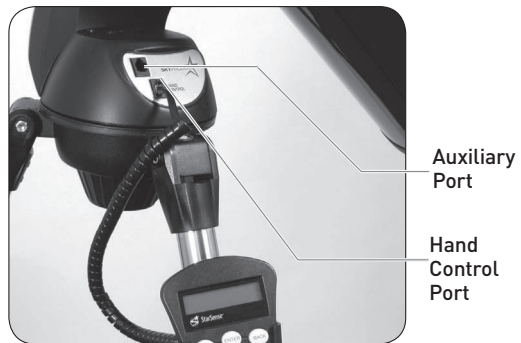

FIGURE 2-8

The StarPointer Finderscope

The StarPointer is a zero magnification pointing tool that uses a coated glass window to superimpose the image of a small red dot onto the object you are viewing. The StarPointer is very useful for finding terrestrial objects in the daytime, and seeing where the telescope is pointing in the night sky.

While keeping both eyes open when looking through the StarPointer, simply move your telescope until the red dot, seen through the StarPointer, merges with the object as seen with your unaided eye. The red dot is produced by light-emitting

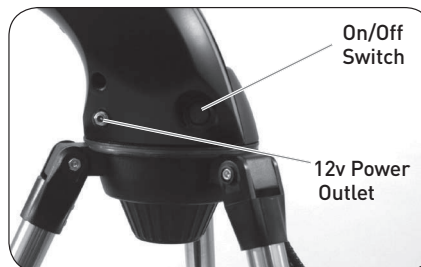

FIGURE 2-9

diode (LED); it is not a laser beam and will not damage the glass window or your eye. The StarPointer comes equipped with a variable brightness control, two axes alignment control and mounting brackets. Before the StarPointer is ready to be used, it must be attached to the telescope tube and properly aligned.

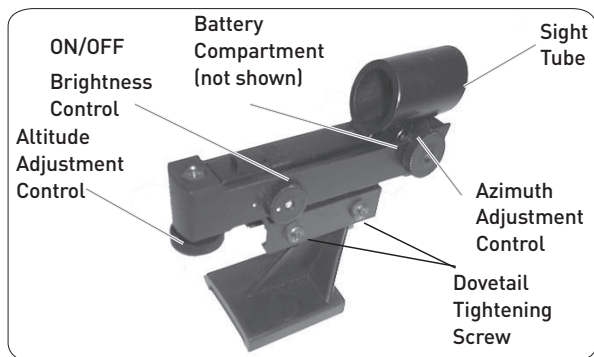

FIGURE 2-10
THE STARPOINTER FINDERSCOPE WITH BRACKET

StarPointer Installation (SkyProdigy 102)

1. Slide the StarPointer bracket into the dovetail mounting platform on top of the focuser assembly (see figure 2-12).
2. Orient the StarPointer so that the sight tube is facing towards the front of the tube.
3. Secure the StarPointer bracket by tightening the thumb screw on the mounting platform.

StarPointer Operation

The StarPointer is powered by a long life 3v lithium battery (#CR2032) located underneath the front portion of the StarPointer. Like all finderscopes, the StarPointer must be properly aligned with the main telescope before it can be used. This is a simple process using the azimuth and altitude control knobs located on the side and bottom of the StarPointer.

1. Before using the StarPointer, you must first remove the protective plastic cover over the battery (see figure 2-13).
2. To turn on the StarPointer, rotate the variable brightness control (see figure 2-10) clockwise until you hear a “click”. To increase the brightness level of the red dot, continue rotating the control knob about 180° until it stops.
3. Locate a distant object and center it in a low power eyepiece in the main telescope. If aligning during the daytime, choose an object at least a quarter of a mile away. If aligning at nighttime, select the Moon or a bright star that is easy to see. Use the four directional arrow buttons on the hand control to move the telescope side-to-side and up and down.
5. With both eyes open, look through the glass window at the alignment star. If the StarPointer is perfectly aligned, you will see the red LED dot overlap the alignment star. If the StarPointer is not aligned, take notice of where the red dot is relative to the bright star.
6. Without moving the main telescope, turn the StarPointer’s azimuth and altitude alignment controls (see figure 2-10) until the red dot is directly over the alignment object.

If the LED dot is brighter than the alignment star, it may make it difficult to see the star. Turn the brightness control counterclockwise, until the red dot is the same brightness as the alignment star. This will make it easier to get an accurate alignment. The StarPointer is now ready to use.

StarPointer Installation (SkyProdigy 6)

Locate the dovetail mounting bracket, which should be already attached to the rear cell of the optical tube.

Slide the mounting track at the bottom of the Star Pointer over the dovetail portion of the bracket. It may be necessary to loosen the two screws on the side of the mounting track before sliding it over the dovetail. The end of the Star Pointer with the glass window should be facing out towards the front of the telescope.

Tighten the two screws on the side of the mounting track to secure the Star Pointer to the dovetail bracket.



FIGURE 2-11
INSTALLING THE STARPOINTER FOR SKYPRODIGY 6



FIGURE 2-12
INSTALLING THE STARPOINTER FOR SKYPRODIGY 102

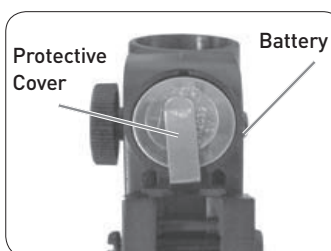

FIGURE 2-13
BATTERY COMPARTMENT

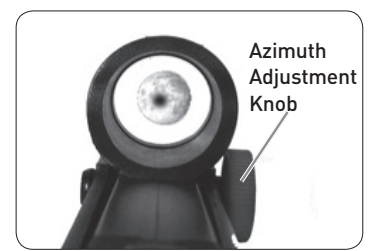

FIGURE 2-14
ALIGNING THE STARPOINTER

HAND CONTROL

The Computerized Hand Control

SkyProdigy's hand controller is designed to give you instant access to all the functions SkyProdigy has to offer. With automatic slewing to over 4,000 objects and common sense menu descriptions, even a beginner can master its variety of features in just a few observing sessions. Below is a brief description of the individual components of SkyProdigy's hand controller:

1. **Liquid Crystal Display (LCD) Window:** Has a four-line, 18 character display screen that has red backlighting for comfortable viewing of telescope information and scrolling text.
2. **Align:** Instructs SkyProdigy to begin the StarSense alignment of your telescope.
3. **Direction Keys:** Allows complete control of SkyProdigy in any direction. Use the direction keys to center objects in the eyepiece or manually slew telescope.
4. **Catalog Keys:** SkyProdigy has a key on the hand control to allow direct access to each of the main catalogs in its 4,000+ object database. SkyProdigy contains the following catalogs in its database:
 - **Solar System** - All 7 planets in our Solar System plus the Moon, Sun and Pluto.
 - **Stars** - Custom lists of all the brightest stars, double stars, variable stars and asterisms.

- **Deep Sky** - Custom lists of all the best Galaxies, Nebulae and Clusters as well as the complete Messier and select NGC objects.
5. **Identify:** Searches SkyProdigy's databases and displays the name and offset distances to the nearest matching objects.
 6. **Menu:** Displays the many setup and utilities functions, such as tracking rate and user defined objects, and many others.
 7. **Option (Celestron Logo):** Can be used in combination with other keys to access more advanced features and functions.
 8. **Enter:** Pressing **ENTER** allows you to select any of SkyProdigy's functions, accept entered parameters and slew the telescope to displayed objects.
 9. **Back:** Pressing **BACK** will take you out of the current menu and display the previous level of the menu path. Press **BACK** repeatedly to get back to a main menu or use to erase data entered by mistake.
 10. **Sky Tour:** Activates the tour mode, which seeks out all the best objects in the sky and automatically slews SkyProdigy to those objects.
 11. **Scroll Keys:** Used to scroll up and down within any of the menu lists. A double arrow symbol on the right side of the LCD indicates that the scroll keys can be used to view additional information.
 12. **Motor Speed:** Instantly changes the motor's rate of speed when the direction buttons are pressed.
 13. **Object Info:** Displays coordinates and useful information about objects selected from SkyProdigy's database.
 14. **RS-232 Jack:** For use with a computer, software programs for point and click slewing capability, and updating firmware via PC.

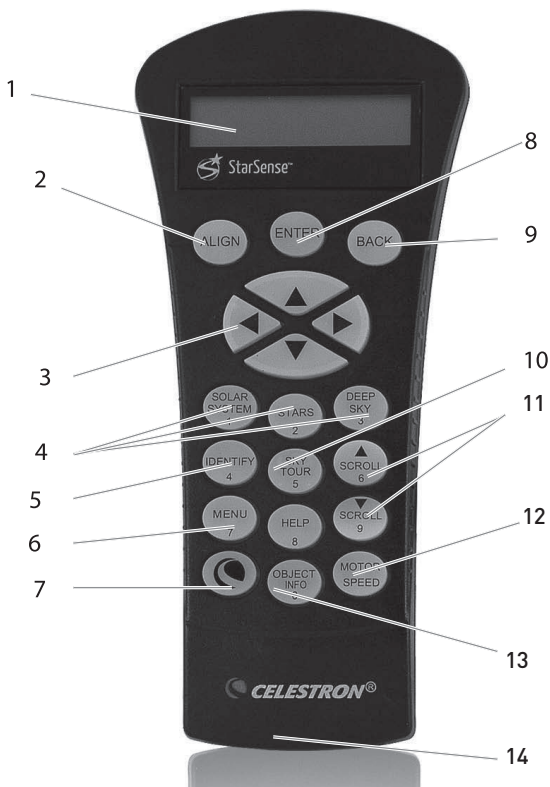

Aligning SkyProdigy

StarSense Alignment

In order for SkyProdigy to accurately point to objects in the sky, it must first align itself to known patterns of stars in the sky. Once aligned, the telescope can create a model of the sky, which it uses to locate any object with known coordinates.

Before beginning the alignment, SkyProdigy must be set up (as described in the previous section) in an outdoor location. Place your telescope in a wide open area away from large trees or building that may obstruct SkyProdigy's view of the sky. Preferably your observing site should have a view as low to the horizon as possible with no bright lights near the telescope.



1. Start out by facing the front of the telescope towards an unobstructed part of the sky, free of any bright lights.
2. Make sure the cap is removed from the camera lens.
3. Press the **ALIGN** button on the hand control to begin the alignment process.

Although SkyProdigy will essentially align itself after pressing the **ALIGN** button, the following is an overview of the StarSense alignment process:

- SkyProdigy will automatically start moving to its “home position”. With the telescope pointed at a clear part of the sky, it will slew (move) upwards, away from the horizon about 25 degrees.
- SkyProdigy will take an image of the sky and display the “Acquiring Image” message on the hand control display. **Once SkyProdigy has begun its alignment process, it is important not to touch or move the telescope** in any way. Also, **while imaging the sky, do not obstruct, cover or shine light into the camera lens** located on the fork arm of the mount. Immediately after imaging, SkyProdigy will automatically slew to another portion of the sky.
- After the first image is taken, the hand control will display “Sensing”. During this time the captured image is internally processed and will display the number of stars that were imaged.
- Once processed, the hand control will display the “Solving” message as it attempts to positively identify the stars in the image.
 1. The hand control will display the “Solved” message once it has identified a positive match.
 2. The hand control will display “No Solve” if it is unable to identify a match. See “Tips for using SkyProdigy” for ways to improve positive alignment matches.
- Once the image has been solved, SkyProdigy will repeat this process and display the “Alignment Complete” message after three images are successfully acquired.

SkyProdigy is now ready to start finding and tracking any of the objects in its 4,000+ object database.

Tips for Aligning SkyProdigy

Remember the following alignment guidelines to make using SkyProdigy as simple and accurate as possible.

- Be sure to level the tripod before you begin alignment. A level tripod will help the telescope better match the images it takes with the actual sky and give you a more accurate determination of your location.
- Make sure the tripod legs are sufficiently tight. If there is any noticeable movement in the tripod while aligning the telescope, it may affect results. You may need to tighten both the leg extension locking bolts and the hinge bolts at the top of the tripod.
- Make sure that the bottom of the mounting bar on the telescope tube is mounted flush against the bottom of the mounting clamp. If the telescope tube is attached at an angle, it will not be accurately aligned with the camera.
- If your SkyProdigy 6 telescope is out of collimation, the optics may no longer be aligned with the optical axis of the camera resulting in unsuccessful alignments or poor pointing accuracy.
- Once your SkyProdigy 6 has been collimated, it is recommended that you calibrate the camera to match the optics. For information on calibrating the camera, see the Calibrate option under the StarSense Camera section of the manual.
- If you notice that the pointing accuracy of the telescope is noticeably worse on solar system objects (planets and the Moon) than it is on stars, you may need to reset the time/location information to improve accuracy. Use the Time and Location menu in the hand control to update time/location information.

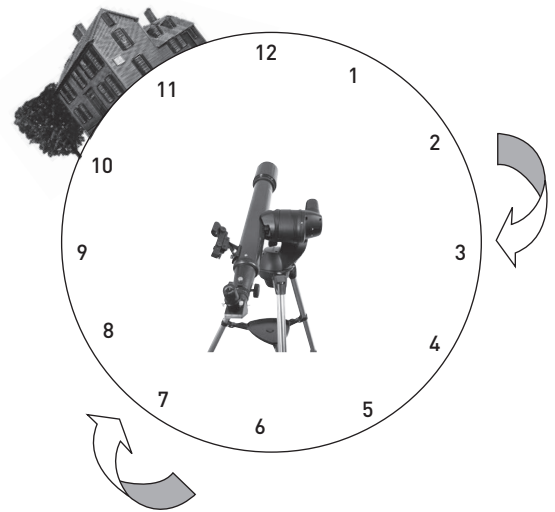

For best alignment results, make sure that your telescope is pointed towards an open area of the sky that has a *clear horizon to the right (clockwise) of its starting position.* Once the first alignment image is taken, SkyProdigy will move clockwise at least 90° to take a second image somewhere between the 4 and 6 o'clock position. If the horizon is blocked between the 3 and 6 o'clock position, SkyProdigy will continue to move clockwise until it finds an unobstructed view of the sky. The third image will be taken between the 7 and 9 o'clock position. The 10 to 12 o'clock position will only be used if the sky is obstructed in its previous position.

SkyProdigy also provides two other alignment methods that can be used instead of the StarSense Auto Alignment. To access the additional alignment methods, Press and hold the **OPTION** Key and press the **ALIGN** button. This will display the StarSense Manual Alignment and Solar System Alignment options. Use the **UP/DOWN** Scroll keys to select either option.

Manual StarSense Alignment

Manual StarSense Alignment allows the user to point the telescope in the part of the sky they wish to use for taking alignment images. This is particularly useful in locations where the horizon is partially obstructed and you only have limited visibility to the sky. Manual StarSense Alignment will not give you as accurate an alignment as the automatic alignment described above. However, it will provide good pointing accuracy throughout the visible region of the sky that was used for the alignment. To use Manual StarSense Alignment:

1. With the telescope powered on, press and hold the **OPTION** Key and press the **ALIGN** button. This will allow you see the additional alignment options that are available.
2. Use the **UP/DOWN** Scroll keys to select the StarSense Manual option and press **ENTER**.
3. The telescope will automatically move to its home position and should be pointed approximately 25° above the horizon.
4. Make sure the cap is removed from the camera lens.
5. If the telescope is not pointing at a clear portion of the sky, use the direction buttons to aim the telescope at a clear part of sky and press **ENTER**. **When moving the telescope, remember to always finish slewing using the UP and RIGHT direction buttons on the hand control.** A check mark will display at the right of the hand control display to confirm that the **UP** and **RIGHT** direction buttons have been used. This will help eliminate much of the mechanical backlash in the gears and help ensure the best possible alignment.
6. SkyProdigy will then begin taking the first image and will display **"Acquiring Image"** on the hand control display.
7. Once the image is captured and processed, the display will ask you to select the next alignment point. Use the direction buttons to slew the telescope to another clear portion of sky. Once again, use the **UP** and **RIGHT** direction buttons to finish slewing the telescope. Press **ENTER**.
8. Once the second image is captured and processed, use the direction buttons to slew the telescope to a final clear portion of sky as far away as possible from the first alignment position. Press **ENTER**.

Once the third image is processed, SkyProdigy is aligned and ready for use.

Tips for Using Manual StarSense Alignment

If SkyProdigy is missing bright objects or not placing them near the center of a lower power eyepiece, press the **HELP** button to access the "Can't see objects" utility. See Help menu feature for more information on this feature.

Solar System Alignment

Solar System Align is designed to provide good tracking and GoTo performance by using solar system objects (Sun, Moon and planets) to align the telescope with the sky. Solar System Align is a great way to align your telescope for daytime viewing as well as a quick way to align the telescope for night time observing. Since the StarSense camera can not detect celestial objects during the daytime, Solar System Align is done using the eyepiece.

WARNING



- **Place cap over the camera lens!** Since you may wish to use the Sun for your alignment, remember to place the cap over the camera lens to protect the imaging sensor.
- **Never look directly at the Sun with the naked eye** or with a telescope (unless you have the proper solar filter). Permanent and irreversible eye damage may occur.

1. To access Solar System Align, hold down the **OPTION** button while pressing the **ALIGN** button. This will allow you see the additional alignment options that are available.
2. Use the **UP/DOWN** Scroll buttons to select Solar System Align from the alignment options. Press **ENTER** to accept the time/site information displayed on the hand control or press **BACK** to accept the displayed values.
3. Use the number key pad to enter updated information.
4. Use the **UP/DOWN** Scroll keys to toggle between choices like North/South and time zone information.
5. Use the **UP/DOWN** Scroll keys to select the daytime object (planets, Moon or Sun) you wish to align. Press **ENTER**. The hand control will only display the solar system objects that are above the horizon for the day and time selected.
 - SkyProdigy then asks you to center in the eyepiece the alignment object you selected. Use the direction arrow buttons to slew the telescope to the alignment object and carefully center it in the StarPointer finderscope. Press **ENTER** when centered.
 - Then, center the object in the eyepiece and press **ALIGN**.

Once in position, SkyProdigy will model the sky based on this information and display **Alignment Complete**.

Tips for Using Solar System Alignment

When using Solar System Alignment to view the Moon or Sun, you can change the tracking speed to the appropriate setting for these objects. You can access the tracking menu by pressing: **MENU**>Telescope Setup>Tracking

Refine Alignment

Once the telescope is aligned using Solar System Align, you have the option of adding additional alignment objects (either other planets or stars from the Named Star Catalog) in order to improve pointing accuracy. To add an alignment object:

1. Select the desired object from the Named Star or Solar System database and slew to it.
2. Press the **ALIGN** button on the hand control.
3. The display will then ask you if you want to add an alignment object or replace the existing one.
4. Select **ADD** to add the additional alignment object. If an additional object has already been added, then you have the option of replacing one of the existing objects with the new object.
5. Carefully center the object in the eyepiece using the **UP** and **RIGHT** buttons for final centering.
6. Press **ALIGN** to add the alignment object.

Tips for Using Solar System Align

For safety purposes, the Sun will not be displayed in any of the hand control's object lists unless it is enabled from the Database Setup Menu. To allow the Sun to be displayed on the hand control, do the following:

1. Press the **UNDO** button until the display reads "SkyProdigy Ready".
2. Press the **MENU** button and use the **UP** and **DOWN** keys to select the Utilities menu. Press **ENTER**.
3. Use the **UP** and **DOWN** keys to select Menu Level and press **ENTER**.
4. Use the **UP** and **DOWN** keys to select Advanced and press **ENTER**. This will give you access to the Database Setup menu that you will need to allow the Sun to be displayed.
5. Press **BACK** until the Menu option is displayed.
6. Use the **UP** and **DOWN** keys to select Database Setup and press **ENTER**.
7. Use the **UP** and **DOWN** keys to select Allow Sun and press **ENTER**.
8. Use the **UP** and **DOWN** keys to toggle the solar option to Yes and press **ENTER**.

The Sun can be removed from the display by using the same procedure as above.

Object Catalog

Selecting an Object

Now that the telescope is properly aligned, you can choose an object from any of the catalogs in the SkyProdigy's database. The hand control has a key designated for each category of objects in its database; Solar System objects, Stars and Deep Sky objects.

- **Solar System** - The Solar System catalog will display all the planets (and Moon) in our Solar System that are currently visible in the sky. To allow the Sun to be displayed as an option in the database, see Allow Sun option in the Database Setup section of the manual.
- **Stars** - The Stars catalog displays a custom lists of all the

brightest stars, double (Binary) stars, variable stars, and selected asterisms.

- **Deep Sky** -The Deep Sky catalog displays a list of all the best Galaxies, Nebulae and Clusters, as well as the complete Messier and select NGC objects. There is also an alphabetical list of all deep sky objects in order by their common name.

The Messier and NGC catalogs require the user to enter a numeric designation. Selecting these catalogs will display a blinking cursor next to the name of the catalog chosen. Use the numeric key pad to enter the number of any object within these standardized catalogs. For example, to find the Orion Nebula, press the "**M**" key and enter "042".

When scrolling through a long list of objects, holding down either the **UP** or **DOWN** key will allow you to scroll through the catalog at a rapid speed. Holding down the option button while pressing the **UP/DOWN** buttons will allow you to scroll through the database three objects at a time.

Slewing to an Object

Once the desired object is displayed on the hand control screen, you have two options:

- **Press the OBJECT INFO Key.** This will give you useful information about the selected object such as magnitude, constellation and extended information about the most popular objects.
 - Use the **UP/DOWN** arrow buttons to scroll through the displayed object info.
 - Use the **BACK** button or **OBJECT INFO** to return to the object database.
- **Press the ENTER Key.** This will automatically slew the telescope to the coordinates of the object displayed on the hand control. While the telescope is slewing to the object, the user can still access many of the hand control functions (such as displaying information about the object).

Caution: Never slew the telescope when someone is looking into the eyepiece. The telescope can move at fast slew speeds and may hit an observer in the eye.

SkyTour Button

The SkyProdigy includes a tour feature which automatically allows the user to choose from a list of interesting objects based on the date and time in which you are observing. The automatic tour will display only those objects that are within your set catalog filters limits. To activate the Tour feature, press the **SKY TOUR** key on the hand control.

- Press the **SKY TOUR** button on the hand control.
- Use the **SCROLL** buttons to select Best of Tonight.
- SkyProdigy will automatically slew in azimuth to its starting position which will help minimize the chance of wrapping the power cord during the tour.
- SkyProdigy will display the best objects to observe that are currently in the sky.
 - To see information and data about the displayed object, press the **OBJECT INFO** key. Press it once to display the coordinates of the object. Press it again to display the

coordinates of the object. Press it again to display the text description. Press **BACK** to return to the previous screen.

- To slew to the object displayed, press **ENTER**.
- To see the next tour object, press the **DOWN** key.

Identify Button

Pressing the **IDENTIFY** button will search SkyProdigy's database catalogs and display the name and angular distances to the nearest matching objects from the telescope's current location. This feature can serve two purposes. First, it can be used to identify an unknown object in the field of view of your eyepiece. Additionally, Identify Mode can be used to find other celestial objects that are close to the objects you are currently observing.

For example, if your telescope is pointed at the brightest star in the constellation Lyra, choosing Identify will no doubt return the star Vega as the star you are observing. However, the Identify feature will also search its NGC and Solar System databases and display any planets or Deep Sky objects that are close by. In this example, the Ring Nebula (M57) would display as being approximately 6° away.

The brightness and proximity of the objects displayed can be defined by the user using the Identify Filter under Telescope Setup.

Direction Buttons

The SkyProdigy has four direction buttons in the center of the hand control which control the telescope motion in altitude (up and down) and azimuth (left and right). The telescope can be controlled at nine different speed rates.

1 = 2x	6 = .3° / sec
2 = 4x	7 = 1° / sec
3 = 8x	8 = 2° / sec
4 = 16x	9 = 3.5° / sec
5 = 32x	

Nine available slew speeds

Motor Speed Button

Pressing the **MOTOR SPEED** button (12) allows you to instantly change the speed rate of the motors from high speed slew rate to precise guiding rate or anywhere in between. Each rate corresponds to a number on the hand controller key pad. The number 9 is the fastest rate (approximately 3.5° per second, depending on power source) and is used for slewing between objects and locating alignment stars. The number 1 on the hand control is the slowest rate (2x sidereal) and can be used for accurate centering of objects in the eyepiece. To change the speed rate of the motors:

- Press the **MOTOR SPEED** key on the hand control. The LCD will display the current speed rate.
- Press the number on the hand control that corresponds to the desired speed.

The hand control has a "double button" feature that allows you to instantly speed up the motors without having to choose a speed rate. To use this feature, simply press the arrow button that corresponds to the direction that you want to move the telescope. While holding that button down, press the opposite directional button. This will increase the speed to the maximum slew rate.

When using the **UP** and **DOWN** buttons on the hand control, the slower slew rates (6 and lower) move the motors in the opposite direction than the faster slew rates (7- 9). This is done so that an object will move in the appropriate direction when looking into the eyepiece (i.e. pressing the up arrow button will move the star upwards in the field of view of the eyepiece). However, if any of the slower slew rates (rate 6 and below) are used to center an object in the StarPointer, you may need to press the opposite directional button to make the telescope move in the correct direction.

Help Button

The **HELP** button gives you instant access to helpful information and useful utilities that can help improve the pointing accuracy of your telescope.

- General FAQ – Is a quick reference to many of the features and function of your telescope.
- Glossary – Provides definition to many astronomical terms you may come across while using your telescope.
- The **HELP** button can also be used to diagnose and improve pointing accuracy should you notice that bright objects are not well centered (or completely missing) in the eyepiece. This is particularly useful when using the StarSense Manual alignment process in which only a small portion of the sky is used to align the telescope. To use the **HELP** button to improve accuracy:
 1. Slew to the database object that is not visible (or not well centered) in the eyepiece.
 2. After the slew is complete press the **HELP** button. Do not attempt to use the direction buttons to manually search for the object.
 3. The telescope will then slew to a nearby bright star and take a reference image. SkyProdigy will make adjustments to its sky alignment model based on the stars captured in the image. Once complete, slew the telescope back to the original object. You should notice a considerable improvement in pointing accuracy in that region of the sky.

Menu Button

SkyProdigy contains many user defined setup functions designed to give the user control over the telescope's many features. All of the set up and utility features can be accessed by pressing the **MENU** key and scrolling through the options below.

In order to make navigating through the hand control menus as easy as possible, the menu levels are divided into Basic and Advanced functions.

The **Basic functions**, which are displayed on the hand control when initially powered on, are the commonly used functions that you may need to use every time you use your telescope. These features include updating the time and location information and many utility functions such as changing the backlighting and contrast of the hand control display.

The **Advanced functions** give you the ability to customize the many features of your telescope and the object database, as well as, the Telescope Setup functions needed to improve your mount's overall performance.

To access the Advanced menu items, see Menu Levels under the Utilities section of the manual.

Basic Level Menu Items

Time and Location

View / Modify Location – Allows you to view and make changes to the longitude and latitude of your current location. Please note that changing your current location will result in a loss of alignment. You will need to realign your telescope after making location changes.

View / Modify Time – Allows you to view and make changes to the date, time, time zone offset and Daylight Savings Time.

To modify time and location information:

- Use the number key pad to enter updated information.
- The time needs to be entered in Universal Time, which in some cases may set the date forward or back by one day.
- Use the **UP/DOWN** Scroll keys to toggle between choices like North/South and time zone information.

View / GOTO Location

RA/DEC- Displays the Celestial coordinates (Right Ascension and Declination) of the telescope's current location in the sky.

- To enter new coordinates, press **ENTER** and use the number keypad to enter the desired set of coordinates.
- Use the **UP** and **DOWN** Scroll keys to change the declination from positive to negative and back.
- Press **ENTER** to slew the telescope to the new coordinates.

Utility Features

Scrolling through the **MENU** options will also provide access to several advanced utility functions such as adjusting hand control brightness and restoring factory defaults.

Backlight – This feature allows you to adjust the brightness of both the red keypad light and LCD display for daytime use to conserve power and to help preserve your night vision. Use the **UP/DOWN** Scroll buttons to increase or decrease the numeric value from 0 (off) to 99 (brightest). Press **ENTER** to accept the values. Press **BACK** to exit the menu.

LCD Contrast – Allows you to adjust the contrast of the LCD display. This is useful in different lighting conditions and temperatures that can affect the appearance of the LCD. Use the **UP/DOWN** Scroll buttons to increase or decrease the numeric value from 0 (brightest) to 31 (darkest).

Get Version Info – Selecting this option will allow you to see the current version and build number of the hand control, camera and motor control software. The first set of numbers indicate the hand control software version. For the motor control, the hand control will display two sets of numbers; the first numbers are for azimuth and the second set are for altitude. Use the **UP/DOWN** Scroll buttons to view all the information.

Restore Defaults – Returns SkyProdigy's hand control to its original factory setting. Press **ENTER** to restore the defaults or press **BACK** to escape.

Menu Level – In order to make navigating through the hand control menus as easy as possible, the menu levels are divided into Basic and Advanced functions. To display Advanced features, select the Menu Level option. Under Menu Level select the Advanced option and press **ENTER**.

- The **Basic functions**, which are displayed on the hand control when initially powered on, are the commonly used functions that you may need to use every time you use your telescope. These features include updating the time and location information and many utility functions, such as changing the back lighting and contrast of the hand control display.
- The **Advanced functions** give you the ability to customize the many features of your telescope and the object database, as well as the Telescope Setup functions needed to improve your mount's performance and overall performance.

Advanced Level Menu Items

Database Setup

SkyTour Filters – Allows you to set the minimum magnitude limit (brightness) for objects that will be displayed when the **SKY TOUR** button is pressed. When using your telescope from a dark sky location, set the minimum magnitude to a higher number. When using your telescope from an urban location or when the Moon is full, set the minimum magnitude to a lower number. The filter limit can be set between 0 (very bright objects) and 25.5 (extremely faint objects). Press **ENTER** to accept the value.

Once the filter limit is set, the hand control will display a list of all the object catalogs that are searched when creating the customized SkyTour. To narrow down your search you can select just the catalogs you want to include in the search:

1. Use the **UP** and **DOWN** Scroll buttons to select the desired catalog.
2. Press **ENTER** to select or deselect the catalog.
 - A selected catalog will have a small check mark next to it
 - A deselected catalog will have a small "x" next to it

Catalog Filters - Allows you to set the minimum magnitude limit (brightness) for objects that will be displayed when viewing any of the database catalogs. This will filter out any objects too faint to view for the sky conditions of your observing site.

Identify Filters- Allows you to set the minimum magnitude limit (brightness) and search radius for objects that will be

displayed when the **IDENTIFY** button is pressed. This will not only allow you to set the brightness of the object you want SkyProdigy to identify but also the distance away from its current location.

- The Identify Filter can be set between 0 (very bright objects) and 25.5 (extremely faint objects)
- The search radius filter can be set from 0° to 25.5°

Press **ENTER** to accept the value.

Allow Sun – This menu allows you to enable the Sun as an object that will be displayed under the Solar System object catalog and that can be used when using the Solar System alignment option. Use the **UP** and **DOWN** Scroll buttons to toggle between “yes” and “no” and press **ENTER** to accept.

Telescope Setup

Tracking - In addition to being able to move the telescope with the hand control buttons, SkyProdigy will continually track a celestial object as it moves across the night sky. The tracking rate can be changed depending on what type of object is being observed:

Sidereal	This rate compensates for the rotation of the Earth by moving the telescope at the same rate as the rotation of the Earth, but in the opposite direction.
Lunar	Used for tracking the Moon when observing the lunar landscape.
Solar	Used for tracking the Sun when solar observing using a proper solar filter.
Disable	Turn tracking completely off.

Slew Limits – Sets the limits in altitude that the telescope can slew. The slew limits prevent the telescope tube from slewing to an object below the horizon or slewing to an object that is high enough that the tube might hit one of the tripod legs. However, the slew limits can be customized depending on your needs. For example, if you would like to slew to an object that is close to the zenith and are certain that the tube will not hit the tripod legs, you can set the maximum slew limits to 90° in altitude. Setting your limits to 0 and 90° will allow the telescope to slew to any object above the horizon. Use the **UP/DOWN** Scroll buttons to increase or decrease the numeric value from 0 to 90°. Press **ENTER** to accept the values. Press **BACK** to exit the menu.

Direction Buttons – The direction a star moves in the eyepiece varies depending on the optical accessories being used. This feature can be used to change the direction that the stars moves in the eyepieces when a particular arrow button is being pressed. To reverse the button logic of the direction keys, press the **MENU** button and select Direction Buttons from the Telescope Setup menu. Use the **ENTER** button to select either the Azimuth buttons (left and right) or Altitude buttons (up and down). Pressing the **UP** and **DOWN** Scroll buttons to reverse the direction of the hand control buttons from their current state. Press **BACK** to exit the menu. Direction Buttons will only change the eyepiece rates (rate 1-6) and will not affect the slew rates (rate 7-9).

Cordwrap – Cordwrap safeguards against the telescope slewing more than 360° in azimuth and wrapping cables around the base of the telescope. This is useful any time that the telescope is powered using an external power supply. By default, the cord wrap feature is turned on.

There may be a time when the telescope may not slew to an object from the shortest distance but instead slew to the object from the opposite direction. This is normal and necessary to prevent power cord from wrapping around the telescope.

Backlash Compensation – All mechanical gears have a certain amount of backlash or play between the gears. This play is evident by how long it takes for a star to move in the eyepiece when the hand control arrow buttons are pressed (especially when changing directions). SkyProdigy’s backlash compensation feature allows the user to compensate for backlash by inputting a value which quickly moves the motors just enough to eliminate the play between gears. The amount of compensation needed depends on the slewing rate selected; the slower the slewing rate the longer it will take for the star to appear to move in the eyepiece. Therefore, the backlash compensation will have to be set higher. You will need to experiment with different values; a value between 20 and 50 is usually best for most visual observing. Positive backlash compensation is applied when the mount changes its direction of movement from backwards to forwards. Similarly, negative backlash compensation is applied when the mount changes its direction of movement from forwards to backwards. When tracking is enabled, the mount will be moving in one or both axes in either the positive or negative direction, so backlash compensation will always be applied when a direction button is released and the direction moved is opposite to the direction of travel.

To set the anti-backlash value, scroll down to the backlash compensation option and press **ENTER**. Enter a value from 0-99 for both azimuth and altitude directions and press **ENTER** after each one to save these values. SkyProdigy will remember these values and use them each time it is turned on until they are changed.

StarSense Camera

StarSense Camera settings are an advanced level feature that allows you to calibrate the telescopes camera and customize the camera control settings.

Calibrate – Your telescope’s camera may need to be calibrated if the telescope cannot find objects after being successfully aligned. To Calibrate the camera:

1. Slew the telescope to the bright star that you are trying to find.
2. Select Calibrate from the StarSense menu option.
3. The hand control will display the current pixel position of the center of the camera sensor.
4. Use the direction buttons to manually center the bright star in the eyepiece. Press **ENTER**.

SkyProdigy will then take an image of the sky and calibrate the center of the camera sensor with the star seen in the eyepiece.

SkyProdigy will then take an image of the sky and calibrate the center of the camera sensor with the star seen in the eyepiece.

Note: In order to manually slew the telescope and center a bright star in the eyepiece it may be necessary to first align the StarPointer finderscope with the eyepiece. For instructions on aligning the finderscope, see StarPointer Operation in the Assembly section of this manual.

Capture Setting – Allows the user to set different gain and exposure time settings for the camera to use under different sky conditions. Capture Setting should be changed only if you are having difficulties aligning the telescope using the StarSense alignment method. The options below represent various conditions that could result in unsuccessful alignment under normal capture settings.

- Full Moon – Even under the darkest skies a full Moon can brighten the sky enough to affect alignment.
- Hazy/Urban – Hazy skies combined with light pollution can limit the brightness of stars that the camera can image. These setting represents the default setting that should work under most conditions.
- Suburban – Suburban or residential locations can have many city lights which can adversely affect alignment.
- Dark – When the sky is extremely dark, the camera may record too many stars, needlessly prolonging the processing time.
- Windy – Windy conditions can cause faint stars to blur and not be processed by the camera.
- Custom – Allows the user to manually enter custom settings in case any of the above setting do not apply.

After making changes to the capture settings, perform a StarSense Auto, or Manual alignment and observe the number of stars that are acquired for each image. A minimum of 8 stars are needed, but 20-50 stars produce the best results. If your captured images are not recording enough stars, go to the Custom setting. Increasing the gain or exposure time has the potential to increase the number of stars detected up to the threshold for your observing location, the wind and other factors.

SKYPRODIGY MENU TREE

The following figure is a menu tree showing the sub-menus associated with the **MENU** functions.

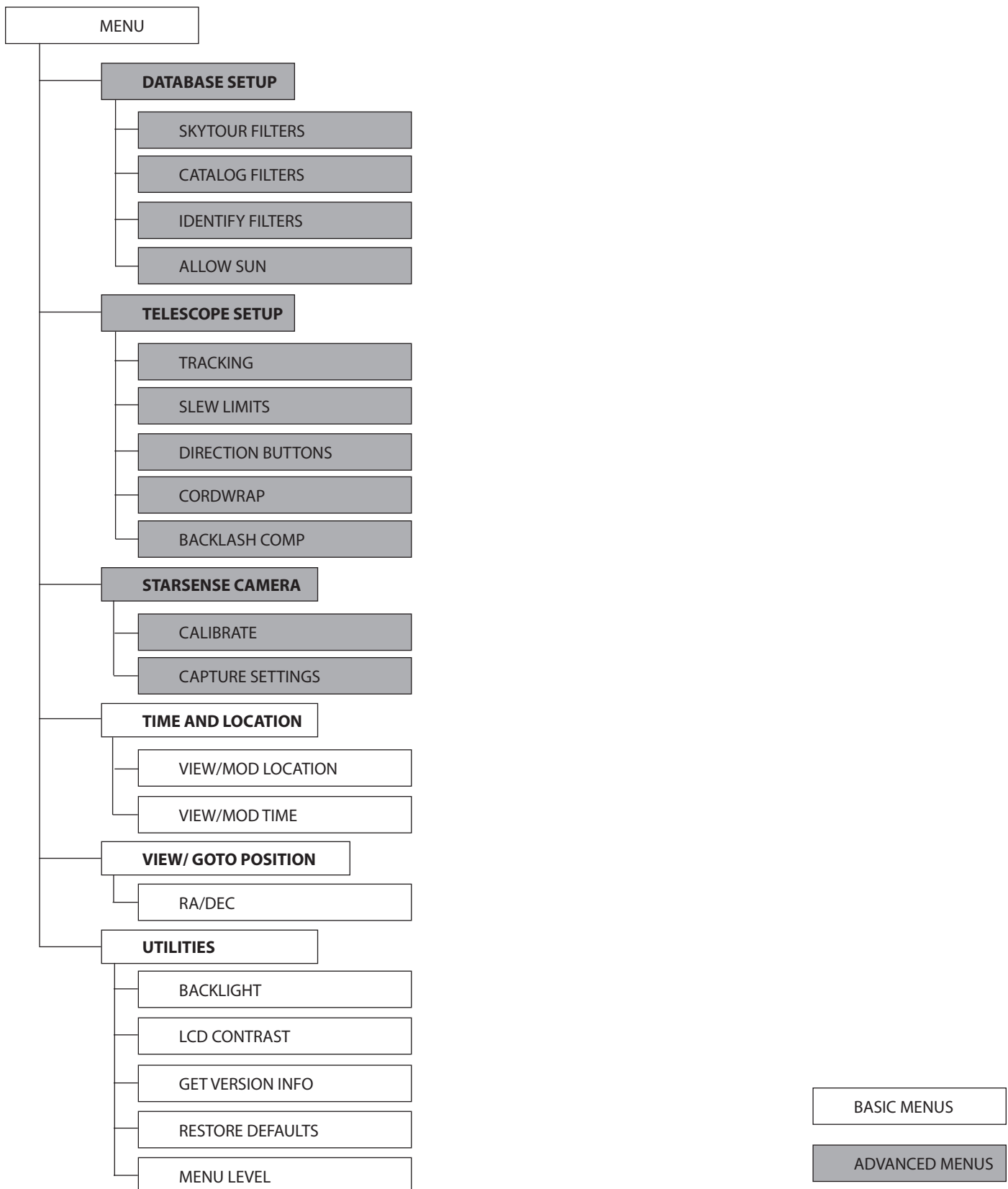

TELESCOPE BASICS

A telescope is an instrument that collects and focuses light. The nature of the optical design determines how the light is focused. Some telescopes, known as refractors, use lenses. Other telescopes, known as reflectors, use mirrors. SkyProdigy 102 telescope is a refractor telescope that uses an objective lens to collect its light. SkyProdigy 6 are reflecting telescopes with a primary and secondary mirror to gather and focus light.

Focusing

Once you have found an object in the telescope, turn the focusing knob until the image is sharp. To focus on an object that is nearer than your current target, turn the focusing knob toward the eyepiece (i.e., so that the focusing tube moves away from the front of the telescope). For more distant objects, turn the focusing knob in the opposite direction. To achieve a truly sharp focus, never look through glass windows or across objects that produce heat waves, such as asphalt parking lots.

Image Orientation

The image orientation of any telescope changes depending on how the eyepiece is inserted into the telescope. When observing through SkyProdigy 102 or 6 using the diagonal, the image will be right side up, but reversed from left to right. When observing straight through, with the eyepiece inserted directly into the telescope, the image will be inverted.



Reversed from left to right, as viewed with a Star Diagonal



Inverted image, as viewed with the eyepiece directly in telescope

For astronomical viewing, out of focus star images are very diffuse, making them difficult to see. If you turn the focus knob too quickly, you can go right through focus without seeing the image. To avoid this problem, your first astronomical target should be a bright object (like the Moon or a planet) so that the image is visible even when out of focus.

Calculating Magnification

You can change the power of your telescope just by changing the eyepiece (ocular). To determine the magnification of your telescope, simply divide the focal length of the telescope by the focal length of the eyepiece used. In equation format, the formula looks like this:

$$\text{Magnification} = \frac{\text{Focal Length of Telescope (mm)}}{\text{Focal Length of Eyepiece (mm)}}$$

Let's say, for example, you are using the 25 mm eyepiece. To determine the magnification you simply divide the focal length of your telescope (for example, SkyProdigy 6 has a focal length of 1500 mm) by the focal length of the eyepiece, 25 mm. Dividing 1,500mm by 25 yields a magnification of 60 power.

Although the power is variable, each instrument under average skies has a limit to the highest useful magnification. The general rule is that 60 power can be used for every inch of aperture. For example, SkyProdigy 102 is 4" (102 mm) in diameter.

Multiplying 4 by 60 gives a maximum useful magnification of 240 power. Although this is the maximum useful magnification, most observing is done in the range of 20 to 35 power for every inch of aperture which is 80 to 140 times for SkyProdigy 102.

Determining Field of View

Determining the field of view is important if you want to get an idea of the angular size of the object you are observing. To calculate the actual field of view, divide the apparent field of the eyepiece (supplied by the eyepiece manufacturer) by the magnification. In equation format, the formula looks like this:

$$\text{True Field} = \frac{\text{Apparent Field of Eyepiece}}{\text{Magnification}}$$

As you can see, before determining the field of view, you must calculate the magnification. Using the example in the previous section, we can determine the field of view using the same 25 mm eyepiece. The 25 mm eyepiece that comes with the SkyProdigy 6 has an apparent field of view of 50°. Divide the 50° by the magnification, which is 60 power. This yields an actual field of view of .83°.

To convert degrees to feet at 1,000 yards, which is more useful for terrestrial observing, simply multiply by 52.5. Continuing with our example, multiply the angular field .83° by 52.5. This produces a linear field width of 43.75 feet at a distance of one thousand yards. The apparent field of each eyepiece that Celestron manufactures is found in the Celestron Accessory Catalog (#93685-11).

General Observing Hints

When working with any optical instrument, there are a few things to remember to ensure you get the best possible image:

- Never look through window glass. Glass found in household windows is optically imperfect, and as a result, may vary in thickness from one part of a window to the next. This inconsistency can and will affect the ability to focus your telescope. In most cases you will not be able to achieve a truly sharp image, while in some cases, you may actually see a double image.
- Never look across or over objects that are producing heat waves. This includes asphalt parking lots on hot summer days or building rooftops.
- Hazy skies, fog and mist can also make it difficult to focus when viewing terrestrially. The amount of detail seen under these conditions is greatly reduced. Also, when photographing under these conditions, the processed film may come out a little grainier than normal with lower contrast and underexposed.
- If you wear corrective lenses (specifically glasses), you may want to remove them when observing with an eyepiece attached to the telescope. When using a camera, however, you should always wear corrective lenses to ensure the sharpest possible focus. If you have astigmatism, corrective lenses must be worn at all times.

CELESTIAL OBSERVING

With your telescope set up, you are ready to use it for observing. This section covers visual observing hints for both solar system and deep sky objects as well as general observing conditions which will affect your ability to observe.

Observing the Moon

Often, it is tempting to look at the Moon when it is full. At this time, the face we see is fully illuminated and its light can be overpowering. In addition, little or no contrast can be seen during this phase.

One of the best times to observe the Moon is during its partial phases (around the time of first or third quarter). Long shadows reveal a great amount of detail on the lunar surface. At low power you will be able to see most of the lunar disk at one time. Change to higher power (magnification) to focus in on a smaller area. Choose the lunar tracking rate from the SkyProdigy's MENU tracking rate options to keep the Moon centered in the eyepiece even at high magnifications.

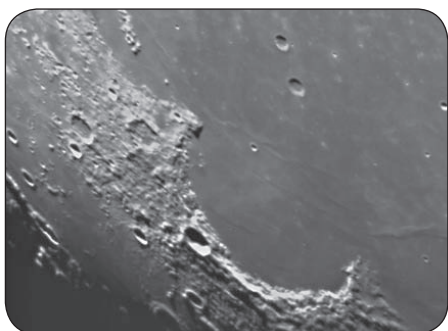

Lunar Observing Hints

- To increase contrast and bring out detail on the lunar surface, use eyepiece filters. A yellow filter works well at improving contrast while a neutral density or polarizing filter will reduce overall surface brightness and glare.

Observing the Planets

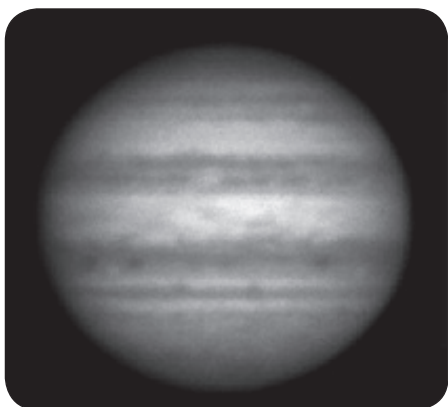

Other fascinating targets include the five naked eye planets. You can see Venus go through its lunar-like phases. Mars can reveal a host of surface detail and one, if not both, of its polar caps. You will be able to see the cloud belts of Jupiter and the Great Red Spot (if it is visible at the time you are observing). In addition, you will also be able to see the moons of Jupiter as they orbit the giant planet. Saturn, with its beautiful rings, is easily visible at moderate power.

Planetary Observing Hints

- Remember that atmospheric conditions are usually the limiting factor on how much planetary detail will be visible. So, avoid observing the planets when they are low on the horizon or when they are directly over a source of radiating heat, such as a rooftop or chimney. Refer to the "Seeing Conditions" later in this section.
- To increase contrast and bring out planetary surface detail, try using Celestron eyepiece filters.

Observing the Sun

Although overlooked by many amateur astronomers, solar observation is both rewarding and fun. However, because the Sun is so bright, special precautions must be taken when observing our nearest star so as not to damage your eyes or your telescope.

Never project an image of the Sun through the telescope. Tremendous heat build-up may result inside the optical tube. This can damage the telescope and/or any accessories attached to the telescope.

For safe solar viewing, use a solar filter that reduces the intensity of the Sun's light, making it safe to view. With a filter you can see sunspots as they move across the solar disk and faculae, which are bright patches seen near the Sun's edge.

Solar Observing Hints

- The best time to observe the Sun is in the early morning or late afternoon when the air is cooler.
- To center the Sun without looking into the eyepiece, watch the shadow of the telescope tube until it forms a circular shadow.
- To ensure accurate tracking on the Sun, be sure to select solar tracking rate.

Observing Deep Sky Objects

Deep sky objects are simply those objects outside the boundaries of our solar system. They include star clusters, planetary nebulae, diffuse nebulae, double stars and other galaxies outside our own Milky Way. Most deep sky objects have a large angular size. Therefore, low-to-moderate power is all you need to see them. Visually, they are too faint to reveal any of the color seen in long exposure photographs. Instead, they appear black and white. And, because of their low surface brightness, they should be observed from a dark sky location. Light pollution around large

urban areas washes out most nebulae making them difficult, if not impossible, to observe. Light Pollution Reduction filters help reduce the background sky brightness, thus increasing contrast.

Seeing Conditions

Viewing conditions affect what you can see through your telescope during an observing session. Conditions include transparency, sky illumination and seeing. Understanding viewing conditions and the effect they have on observing will help you get the most out of your telescope.

Transparency

Transparency is the clarity of the atmosphere which is affected by clouds, moisture and other airborne particles. Thick cumulus clouds are completely opaque while cirrus can be thin, allowing the light from the brightest stars through. Hazy skies absorb more light than clear skies making fainter objects harder to see and reducing contrast on brighter objects. Aerosols ejected into the upper atmosphere from volcanic eruptions also affect transparency. Ideal conditions are when the night sky is inky black.

Sky Illumination

General sky brightening caused by the Moon, aurorae, natural airglow and light pollution greatly affect transparency. While not a problem for the brighter stars and planets, bright skies reduce the contrast of extended nebulae making them difficult, if not impossible, to see. To maximize your observing, limit deep sky viewing to moonless nights far from the light polluted skies found around major urban areas. LPR filters enhance deep sky viewing from light polluted areas by blocking unwanted light while transmitting light from certain deep sky objects. You can, on the other hand, observe planets and stars from light polluted areas or when the Moon is out.

Seeing

Seeing conditions refers to the stability of the atmosphere and directly affects the amount of fine detail seen in extended objects. The air in our atmosphere acts as a lens which bends and distorts incoming light rays. The amount of bending depends on air density. Varying temperature layers have different densities and, therefore, bend light differently. Light rays from the same object arrive slightly displaced creating an imperfect or smeared image. These atmospheric disturbances vary from time-to-time and place-to-place. The size of the air parcels compared to your aperture determines the "seeing" quality. Under good seeing conditions, fine detail is visible on the brighter planets like Jupiter and Mars, and stars are pinpoint images. Under poor seeing conditions, images are blurred, and stars appear as blobs.

The conditions described here apply to both visual and photographic observations.



Seeing conditions directly affect image quality. These drawings represent a point source (i.e., star) under bad seeing conditions (left) to excellent conditions (right). Most often, seeing conditions produce images that lie somewhere between these two extremes.

TELESCOPE MAINTENANCE

While your SkyProdigy telescope requires little maintenance, there are a few things to remember that will ensure your telescope performs at its best.

Care and Cleaning of the Optics

Occasionally, dust and/or moisture may build up on the lens of your telescope. Special care should be taken when cleaning any instrument so as not to damage the optics.

If dust has built up on the optics, remove it with a brush (made of camel's hair) or a can of pressurized air. Spray at an angle to the lens for approximately two to four seconds. Then, use an optical cleaning solution and white tissue paper to remove any remaining debris. Apply the solution to the tissue and then apply the tissue paper to the lens. Low pressure strokes should go from the center of the corrector to the outer portion. **Do NOT rub in circles!**

You can use a commercially made lens cleaner or mix your own. A good cleaning solution is isopropyl alcohol mixed with distilled water. The solution should be 60% isopropyl alcohol and 40% distilled water. Or, liquid dish soap diluted with water (a couple of drops per one quart of water) can be used.

To minimize the need to clean your telescope, replace all lens covers once you have finished using it. This will prevent contaminants from entering the optical tube.

Collimation (For SkyProdigy 6)

The optical performance of your SkyProdigy telescope is directly related to its collimation, that is the alignment of its optical system. Your SkyProdigy was collimated at the factory after it was completely assembled. However, if the telescope is dropped or jarred severely during transport, it may have to be collimated.



FIGURE 6-1
Collimation Adjustment Screws

The SkyProdigy 102 has fixed optical systems that should not come out of collimation. The SkyProdigy 6, however has three collimation screws that can be used to adjust the alignment of the secondary mirror.

To check the collimation of your telescope you will need a light source. A bright star near the zenith is ideal since there is a minimal amount of atmospheric distortion. Make sure that tracking is on so that you won't have to manually track the star. Or, if you do not want to power up your telescope, you can use Polaris. Its

position relative to the celestial pole means that it moves very little thus eliminating the need to manually track it.

Before you begin the collimation process, be sure that your telescope is in thermal equilibrium with the surroundings. Allow 45 minutes for the telescope to reach equilibrium if you move it between large temperature extremes.

To verify collimation, view a star near the zenith. Use a medium to high power ocular - 12mm to 6mm focal length. It is important to center a star in the center of the field to judge collimation. Slowly cross in and out of focus and judge the symmetry of the star. If you see a systematic skewing of the star to one side, then recollimation is needed.



FIGURE 6-2

Even though the star pattern appears the same on both sides of focus, they are asymmetric. The dark obstruction is skewed off to the left side of the diffraction pattern indicating poor collimation.

NOTE: Once your SkyProdigy 6 has been collimated, the optics may no longer be aligned with the optical axis of the camera resulting in unsuccessful alignments or poor pointing accuracy. Therefore, it is recommended that you calibrate the camera after collimation. For information on calibrating the camera, see the Calibrate option under the StarSense Camera section of the manual.

To accomplish this, you need to tighten the secondary collimation screw(s) that move the star across the field toward the direction of the skewed light. These screws are located in the secondary mirror holder (see figure 6-1). Make only small 1/8 to 1/8 adjustments to the collimation screws and re-center the star by moving the scope before making any improvements or before making further adjustments.

To make collimation a simple procedure, follow these easy steps:

1. While looking through a medium to high power eyepiece, de-focus a bright star until a ring pattern with a dark shadow appears (see figure 6-3). Center the de-focused star and notice in which direction the central shadow is skewed.
2. Place your finger along the edge of the front cell of the telescope (be careful not to touch the corrector plate), pointing towards the collimation screws. The shadow of your finger should be visible when looking into the eyepiece. Rotate your finger around the tube edge until its shadow is seen closest to the narrowest portion of the rings (i.e. the same direction in which the central shadow is skewed).
3. Locate the collimation screw closest to where your finger is positioned. This will be the collimation screw you will need to adjust first. (If your finger is positioned exactly between two of the collimation screws, then you will need to adjust the screw opposite where your finger is located).

4. Use the hand control buttons to move the de-focused star image to the edge of the field of view, in the same direction that the central obstruction of the star image is skewed.

5. While looking through the eyepiece, use a screw driver to turn the collimation screw you located in step 2 and 3. Usually a tenth of a turn is enough to notice a change in collimation. If the star image moves out of the field of view in the direction that the central shadow is skewed, than you are turning the collimation screw the wrong way. Turn the screw in the opposite direction, so that the star image is moving towards the center of the field of view.

6. If while turning you notice that the screws get very loose, then simply tighten the other two screws by the same amount. Conversely, if the collimation screw gets too tight, then loosen the other two screws by the same amount.

7. Once the star image is in the center of the field of view, check to see if the rings are concentric. If the central obstruction is still skewed in the same direction, then continue turning the screw(s) in the same direction. If you find that the ring pattern is skewed in a different direction, than simply repeat steps 2 through 6 as described above for the new direction.

Perfect collimation will yield a star image very symmetrical just inside and outside of focus. In addition, perfect collimation delivers the optimal optical performance specifications that your telescope is built to achieve.

If seeing (i.e., air steadiness) is turbulent, collimation is difficult to judge. Wait until a better night if it is turbulent or aim to a steadier part of the sky. A steadier part of the sky is judged by steady versus twinkling stars.

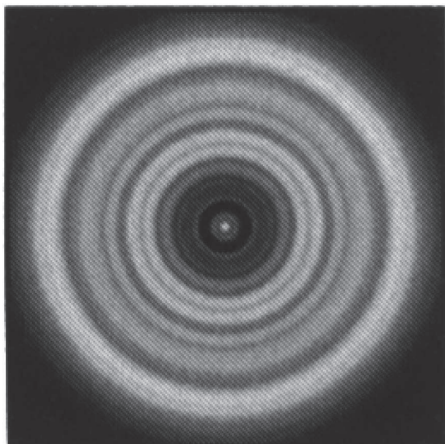

FIGURE 6-3

A collimated telescope should appear symmetrical with the central obstruction centered in the star's diffraction pattern.

APPENDIX A - TECHNICAL SPECIFICATIONS

Optical Specification

	SkyProdigy 102	SkyProdigy 6
Design	Refractor	Schmidt-Cassegrain
Aperture	102 mm	152 mm
Focal Length	660 mm	1500 mm
F/ratio of the Optical System	6.5	10
Optical Coatings	Fully Multi Coated	StarBright Coating
Highest Useful Magnification	241x	354x
Resolution: Rayleigh Criterion Dawes Limit	1.37 arc seconds 1.14 arc seconds	.93 arc seconds .77 arc seconds
Light Gathering Power	212x unaided eye	459x unaided eye
Field of View: Standard Eyepiece	1.5°	.83 °
Linear Field of View (at 1000 yds)	81feet	44 feet
Eyepiece Magnification:	26x (25 mm) 73x (9 mm)	60x (25 mm) 167x (9 mm)
Optical Tube Length	27 inches	15 inches

Electronic Specifications

Input Voltage	12v DC Nominal
Batteries Required	8 D-Cell Alkaline

Mechanical Specifications

Motor Type	DC Servo motors with encoders, both axes
Slew Speeds	Nine slew speeds: 3.5° /sec, 2° /sec, 1°/sec, 0.3 /sec, 32x, 16x, 8x, 4x, 2x
Hand Control	Four line, 18 character Liquid Crystal Display 19 fiber optic backlit LED buttons
Fork Arm	Cast aluminum

Software Specifications

Ports	RS-232 communication port on hand control: Aux port on base
Tracking Rates	Sidereal, Solar and Lunar
Alignment Procedures	StarSense Automatic Alignment, StarSense Manual, Solar System Alignment

APPENDIX B - GLOSSARY OF TERMS

A

Absolute Magnitude	The apparent magnitude that a star would have if it were observed from a standard distance of 10 parsecs, or 32.6 light-years. The absolute magnitude of the Sun is 4.8. at a distance of 10 parsecs, it would just be visible on Earth on a clear moonless night away from surface light.
Airy Disk	The apparent size of a star's disk produced even by a perfect optical system. Since the star can never be focused perfectly, 84 per cent of the light will concentrate into a single disk, and 16 per cent into a system of surrounding rings.
Alt-Azimuth Mounting	A telescope mounting using two independent rotation axes allowing movement of the instrument in Altitude and Azimuth.
Altitude	In astronomy, the altitude of a celestial object is its Angular Distance above or below the celestial horizon.
Aperture	The diameter of a telescope's primary lens or mirror; the larger the aperture, the greater the telescope's light-gathering power.
Apparent Magnitude	A measure of the relative brightness of a star or other celestial object as perceived by an observer on Earth.
Arc Minute	A unit of angular size equal to 1/60 of a degree.
Arc Second	A unit of angular size equal to 1/3,600 of a degree (or 1/60 of an arc minute).
Asterism	A small unofficial grouping of stars in the night sky.
Asteroid	A small, rocky body that orbits a star.
Astrology	The pseudoscientific belief that the positions of stars and planets exert an influence on human affairs; astrology has nothing in common with astronomy.
Astronomical Unit (AU)	The distance between the Earth and the Sun. It is equal to 149,597,900 km., usually rounded off to 150,000,000 km.
Aurora	The emission of light when charged particles from the solar wind slams into and excites atoms and molecules in a planet's upper atmosphere.
Azimuth	The angular distance of an object eastwards along the horizon, measured from due north, between the astronomical meridian (the vertical line passing through the center of the sky and the north and south points on the horizon) and the vertical line containing the celestial body whose position is to be measured.

B

Binary Stars	Binary (Double) stars are pairs of stars that, because of their mutual gravitational attraction, orbit around a common center of mass. If a group of three or more stars revolve around one another, it is called a multiple system. It is believed that approximately 50 percent of all stars belong to binary or multiple systems. Systems with individual components that can be seen separately by a telescope are called visual binaries or visual multiples. The nearest "star" to our solar system, Alpha Centauri, is actually our nearest example of a multiple star system, it consists of three stars, two very similar to our Sun and one dim, small, red star orbiting around one another.
--------------	---

C

Celestial Equator	The projection of the Earth's equator onto the celestial sphere. It divides the sky into two equal hemispheres.
Celestial Pole	The imaginary projection of Earth's rotational axis north or south pole onto the celestial sphere.
Celestial Sphere	An imaginary sphere surrounding the Earth, concentric with the Earth's center.
Collimation	The act of putting a telescope's optics into perfect alignment.

D Declination (DEC)	The angular distance of a celestial body north or south of the celestial equator. It may be said to correspond to latitude on the surface of the Earth.
E Ecliptic	The projection of the Earth's orbit on to the celestial sphere. It may also be defined as "the apparent yearly path of the Sun against the stars".
	A telescope mounting using two independent rotation axes allowing movement of the instrument in Altitude and Azimuth.
Equatorial mount	A telescope mounting in which the instrument is set upon an axis which is parallel to the axis of the Earth; the angle of the axis must be equal to the observer's latitude.
F Focal length	The distance between a lens (or mirror) and the point at which the image of an object at infinity is brought to focus. The focal length divided by the aperture of the mirror or lens is termed the focal ratio.
G GoTo	Term used to refer to a computerized telescope or to the act of slewing (moving) a computerized telescope. A unit of angular size equal to 1/60 of a degree.
J Jovian Planets	Any of the four gas giant planets that are at a greater distance from the Sun than the terrestrial planets.
K Kuiper Belt	A region beyond the orbit of Neptune extending to about 1000 AU which is a source of many short period comets.
L Light-Year (ly)	A light-year is the distance light traverses in a vacuum in one year at the speed of 299,792 km/ sec. With 31,557,600 seconds in a year, the light-year equals a distance of 9.46×10^{12} km (5.87×10^6 trillion mi).
M Magnitude	Magnitude is a measure of the brightness of a celestial body. The brightest stars are assigned magnitude 1 and those increasingly fainter from 2 down to magnitude 5. The faintest star that can be seen without a telescope is about magnitude 6. Each magnitude step corresponds to a ratio of 2.5 in brightness. Thus a star of magnitude 1 is 2.5 times brighter than a star of magnitude 2, and 100 times brighter than a magnitude 5 star. The brightest star, Sirius, has an apparent magnitude of -1.6, the Full Moon is -12.7, and the Sun's brightness, expressed on a magnitude scale, is -26.78. The zero point of the apparent magnitude scale is arbitrary.
Meridian	A reference line in the sky that starts at the North Celestial Pole and ends at the South Celestial Pole and passes through the zenith. If you are facing south, the meridian starts from your southern horizon and passes directly overhead to the North Celestial Pole.
Messier	A French astronomer in the late 1700's who was primarily looking for comets. Comets are hazy diffuse objects and so Messier cataloged objects that were not comets to help his search. This catalog became the Messier Catalog, M1 through M110.
N Nebula	Interstellar cloud of gas and dust. Also refers to any celestial object that has a cloudy appearance.
North Celestial Pole	The point in the northern hemisphere around which all the stars appear to rotate. This is caused by the fact that the Earth is rotating on an axis that passes through the North and South Celestial Poles. The star Polaris lies less than a degree from this point and is therefore referred to as the "Pole Star".
Nova	Although Latin for "new" it denotes a star that suddenly becomes explosively bright at the end of its life cycle.
O Open Cluster	One of the groupings of stars that are concentrated along the plane of the Milky Way. Most have an asymmetrical appearance and are loosely assembled. They contain from a dozen to many hundreds of stars.

P Parallax	Parallax is the difference in the apparent position of an object against a background when viewed by an observer from two different locations. These positions and the actual position of the object form a triangle from which the apex angle (the parallax), and the distance of the object can be determined if the length of the baseline between the observing positions is known, and the angular direction of the object from each position at the ends of the baseline has been measured. The traditional method in astronomy of determining the distance to a celestial object is to measure its parallax.
Parfocal	Refers to a group of eyepieces that all require the same distance from the focal plane of the telescope to be in focus. This means when you focus one parfocal eyepiece all the other parfocal eyepieces, in a particular line of eyepieces, will be in focus.
Parsec	The distance at which a star would show parallax of one second of arc. It is equal to 3.26 light-years, 206,265 astronomical units, or 30,800,000,000,000 km. (Apart from the Sun, no star lies within one parsec of us).
Point Source	An object which cannot be resolved into an image because it is too far away or too small is considered a point source. A planet is far away, but it can be resolved as a disk. Most stars cannot be resolved as disks, they are too far away.
R Reflector	A telescope in which the light is collected by means of a mirror.
Resolution	The minimum detectable angle an optical system can detect. Because of diffraction, there is a limit to the minimum angle resolution. The larger the aperture, the better the resolution.
Right Ascension (RA)	The angular distance of a celestial object measured in hours, minutes and seconds along the Celestial Equator eastward from the Vernal Equinox.
S Sidereal Rate	This is the angular speed at which the Earth is rotating. Telescope tracking motors drive the telescope at this rate. The rate is 15 arc seconds per second or 15 degrees per hour.
T Terminator	The boundary line between the light and dark portion of the Moon or a planet.
U Universe	The totality of astronomical things, events, relations and energies capable of being described objectively.
V Variable Star	A star whose brightness varies over time due to either inherent properties of the star or something eclipsing or obscuring the brightness of the star.
W Waning Moon	The period of the Moon's cycle between full and new, when its illuminated portion is decreasing.
Waxing Moon	The period of the Moon's cycle between new and full, when its illuminated portion is increasing.
Z Zenith	The point on the Celestial Sphere directly above the observer.
Zodiac	The zodiac is the portion of the Celestial Sphere that lies within 8 degrees on either side of the Ecliptic. The apparent paths of the Sun, Moon and the planets with the exception of some portions of the path of Pluto, lie within this band. Twelve divisions, or signs, each 30 degrees in width, comprise the zodiac. These signs coincided with the zodiacal constellations about 2,000 years ago. Because of the precession of the Earth's axis, the Vernal Equinox has moved westward by about 30 degrees since that time; the signs have moved with it, and thus no longer coincide with the constellations.

APPENDIX C - TIME ZONE MAP



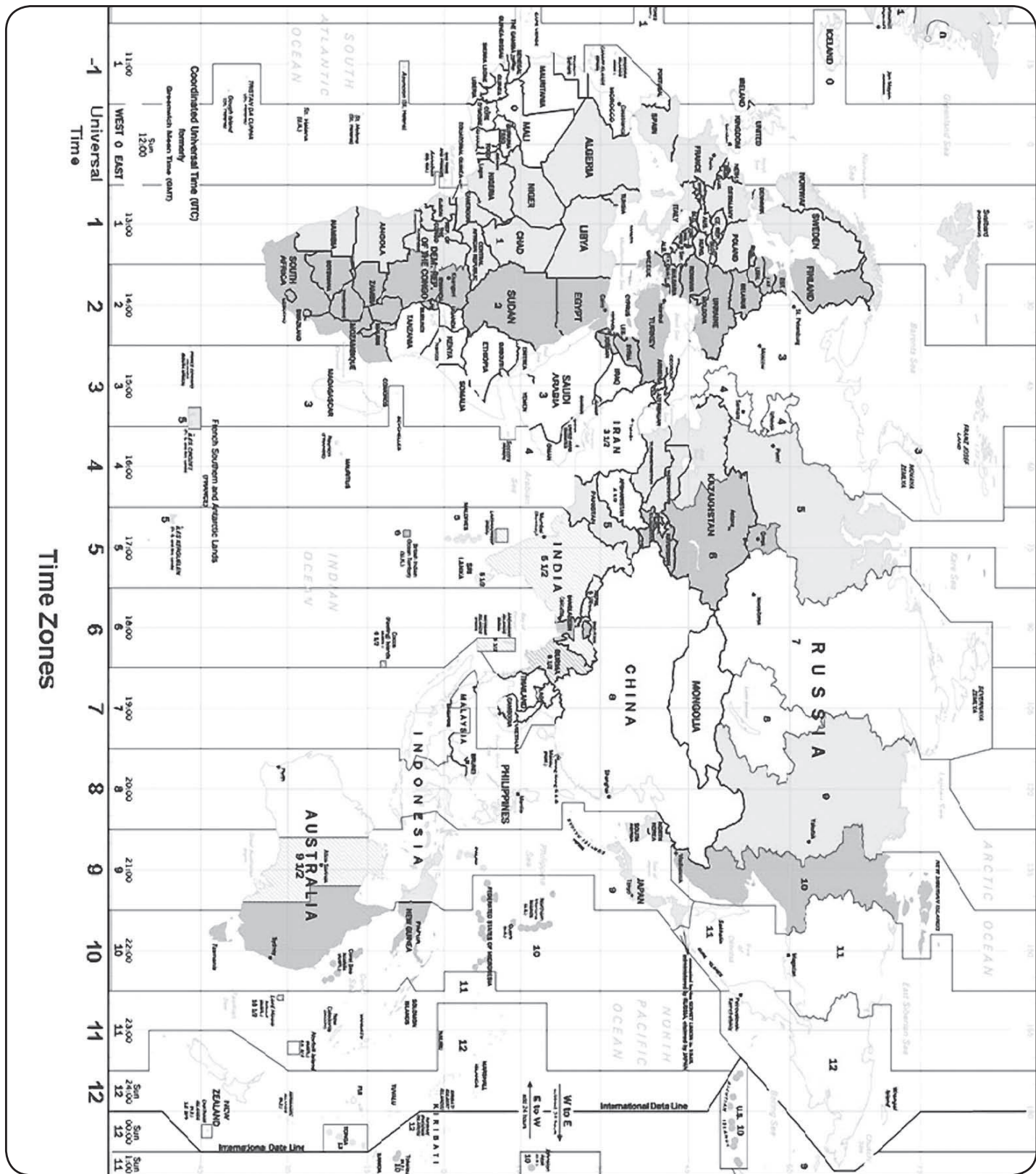



Celestron
2835 Columbia Street
Torrance, CA 90503
Tel. (310) 328-9560
Fax. (310) 212-5835
Web site at <http://www.celestron.com>

Copyright 2012 Celestron
All rights reserved.

(Products or instructions may change without notice or obligation.)

This equipment has been tested and found to comply with the limits for a Class B digital device, pursuant to part 15 of the FCC Rules. These limits are designed to provide reasonable protection against harmful interference in a residential installation. This equipment generates, uses and can radiate radio frequency energy and, if not installed and used in accordance with the instructions, may cause harmful interference to radio communications. However, there is no guarantee that interference will not occur in a particular installation.

If this equipment does cause harmful interference to radio or television reception, which can be determined by turning the equipment off and on, the user is encouraged to try to correct the interference by one or more of the following measures:

- Reorient or relocate the receiving antenna.
- Increase the separation between the equipment and receiver.
- Connect the equipment into an outlet on a circuit different from that to which the receiver is connected.
- Consult the dealer or an experienced radio/TV technician for help.

22090-INST
08-12
Printed in China
\$10.00